

# How To Install Outside Mount Aluminum Blinds w/Hidden Brackets

**CÓMO INSTALAR** llas Persianas de Aluminio de Montaje Exterior con Soportes Escondidos

**COMMENT INSTALLER** en pose extérieure des stores en aluminium avec supports cachés.

**1**

## Everything needed to install your blind

Todo lo necesario para instalar la persiana  
Tout ce qu'il faut pour la pose du store

Optional • Opcional • Facultatif

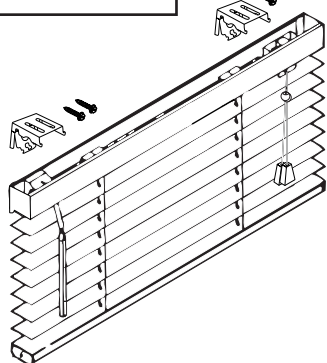
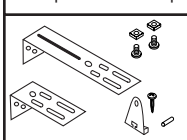

Tools Needed  
Herramientas necesarias  
Outillage nécessaire

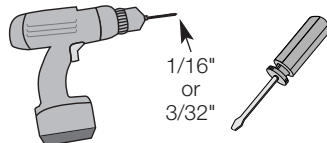

1/16"  
or  
3/32"

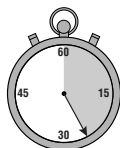

**2**

## Mark location of blind

Marque el lugar de la persiana  
Marquez l'emplacement du store

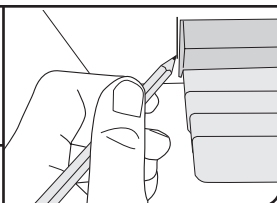

**3**

## Determine bracket location - see template

Determine el lugar de la ménsula  
Déterminez la position du support

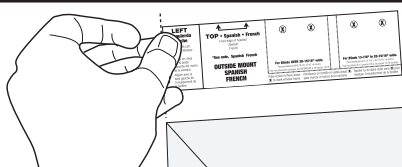

**4**

## Mark bracket location

Marque el lugar de la ménsula  
Marquez la position du support

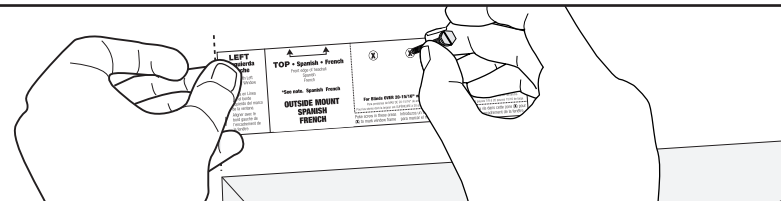

**5**

## Drill holes

Perfore agujeros  
Percez des trous

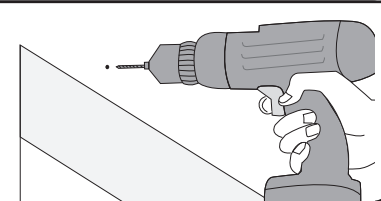

**6**

## Screw in brackets

Atornille las ménsulas  
Vissez les supports

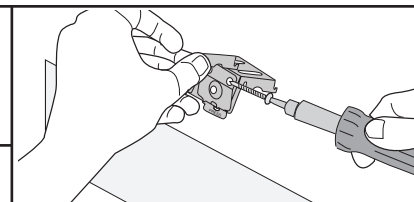

**6**

## Optional projection brackets

Opcional soportes de extensión  
Facultatif supports de projection

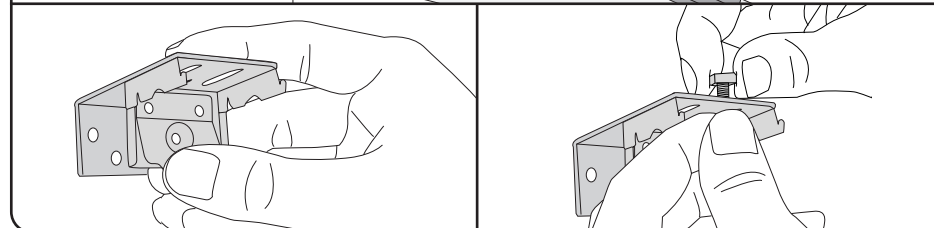
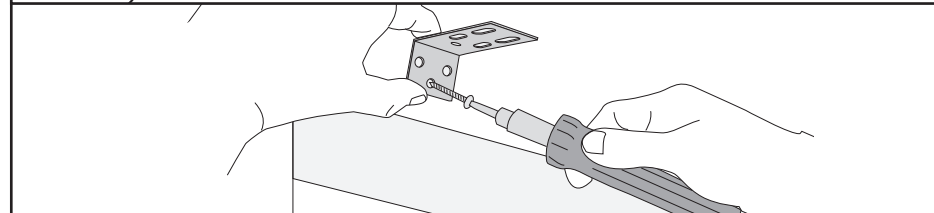

# 7

## Mount blind on brackets

Instale la persiana en las ménsulas  
Posez le store sur les supports

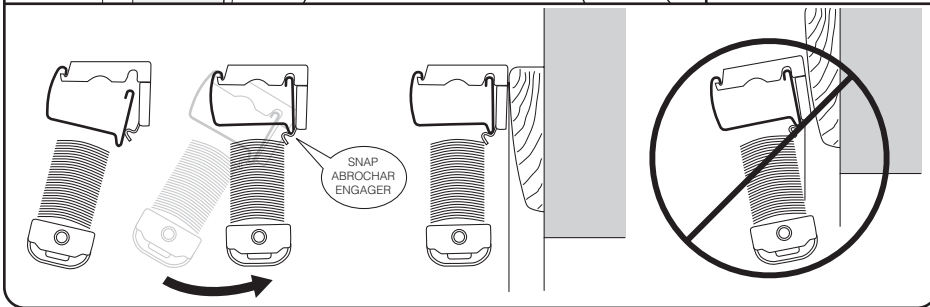
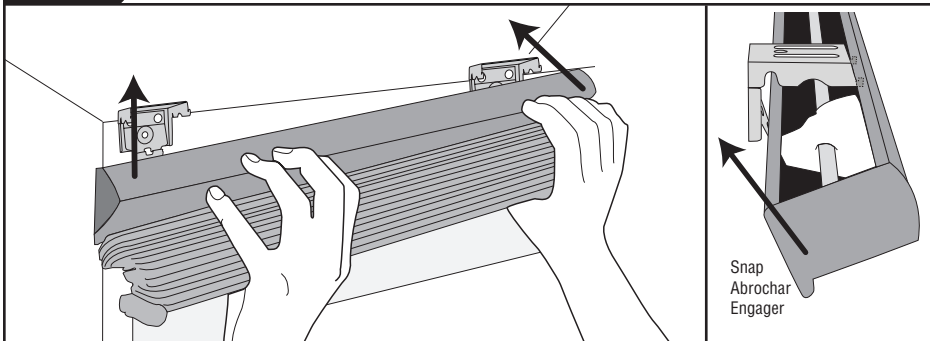

**\*Note:** For blinds under 13-7/8" wide, or all same side control blinds, brackets must be positioned directly over the blind internal tilting components

Nota: Para persianas con un ancho inferior de 13-7/8" y todas las persianas de control del mismo lado, los soportes deben ser colocados directamente sobre los componentes internos de inclinación de la persiana.

Nota: Pour les stores de moins de 13 pouces 7/8 de large, et tous les stores contrôlés du même côté, les supports doivent être positionnés directement au-dessus des pièces d'orientation internes du store.

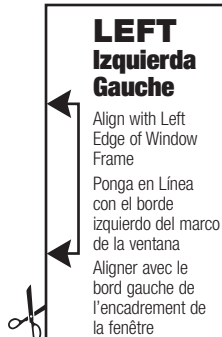

### LEFT Izquierda Gauche

Align with Left Edge of Window Frame  
Ponga en Línea con el borde izquierdo del marco de la ventana  
Aligner avec le bord gauche de l'encadrement de la fenêtre



## Additional Instructions

Instrucciones adicionales  
Instructions supplémentaires

**Remove Blind** • Cómo remover la persiana • Dépose de la persienne

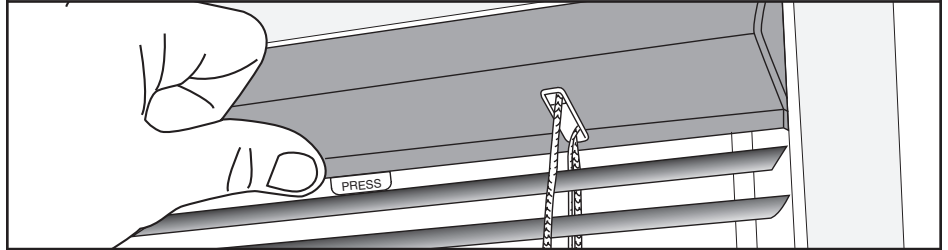

**Attach Tilt Wand** • Accesorio para girar la vara •  
Fixation de la baguette d'inclinaison

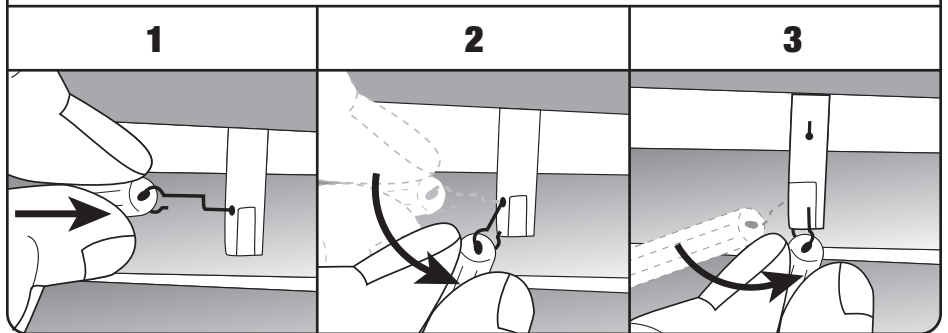

### TOP • Parte Superior • Haut

Front edge of headrail  
Extremo frontal del cabezal  
Bord avant du boîtier

**\*See note. • Ver nota • Voir note.**

### OUTSIDE MOUNT MONTAJE EXTERIOR POSE EXTÉRIEURE



#### For Blinds OVER 20-15/16" wide.

Para persianas de MAS DE 20-15/16" de ancho.  
Pour les stores dont la largeur est SUPÉRIEURE à 20 pouces 15/16.

#### For Blinds 13-7/8" to 20-15/16" wide.

Para persianas entre 13-7/8" y 20-15/16" de ancho.  
Pour les stores de 13 pouces 7/8 à 20 pouces 15/16 de large.

Poke screw in these areas Introdúzca un tornillo en estas áreas (X) Tapoter la vis dans cette zone (X) pour (X) to mark window frame para marcar el marco de la ventana marquer l'encadrement de la fenêtre

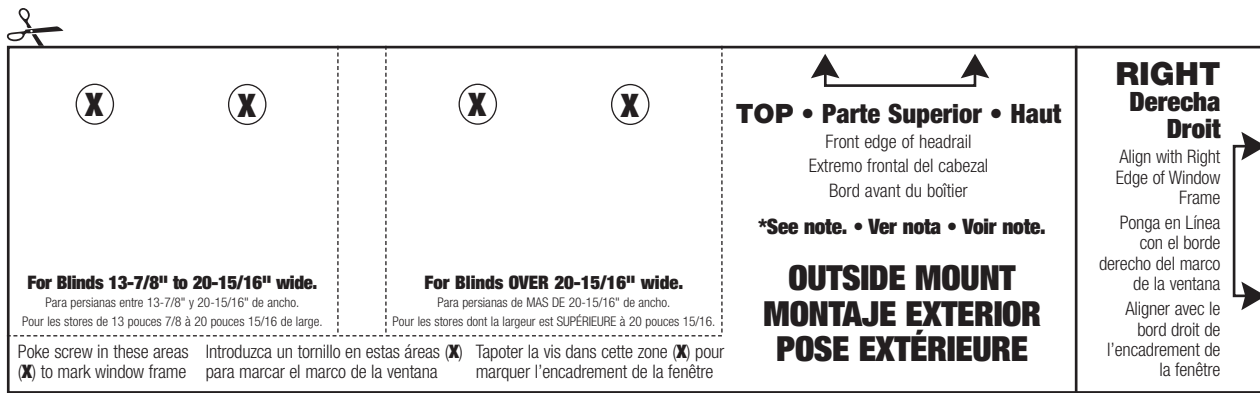

# How To Install Ceiling Mount Aluminum Blinds w/Hidden Brackets

**CÓMO INSTALAR** las Persianas de Aluminio de Montaje de Cielo con Soportes Escondidos

**COMMENT INSTALLER** au plafond des stores en aluminium avec supports cachés.

**Thank you** for purchasing this fine window treatment proudly constructed by us. Your blind has been custom made to your personal specifications with the highest standards of quality and craftsmanship. We have confidence that it will provide you with many years of beauty and easy maintenance. Enjoy!

Follow the easy 'step by step' instructions to install your blind. Should you need additional support, please feel free to call our Customer Service Center at 1-800-221-6352 or e-mail us at windowfashions@springs.com. We will be glad to help you.

Again, we appreciate that you have chosen us to enhance the design and look of your home.



**Gracias** por comprar este fino producto de ventana que hemos fabricado con orgullo. Su persiana ha sido fabricada de acuerdo a las especificaciones personales del cliente con los más altos estándares de artesanía y de calidad. Nosotros tenemos la confianza que nuestro producto le brindará muchos años de belleza y fácil mantenimiento. Le deseamos que la disfrute.

Siga las instrucciones "paso a paso" para instalar su persiana. Si necesitara soporte adicional haga el favor de llamar a nuestro Centro de Servicio al Cliente al teléfono 1-800-221-6352 o envíenos un correo electrónico a windowfashions@springs.com. Estaremos encantados de ayudarle.

Nuevamente le agradecemos que nos haya escogido para mejorar el diseño y la apariencia de su hogar.

**Merci** d'avoir acheté ce superbe traitement pour fenêtre que nous sommes fiers d'avoir exécuté pour vous. Votre store a été fait sur mesure selon votre propre cahier des charges dans un souci d'excellence et de la plus haute technicité. Nous ne doutons pas qu'il vous offrira des années de beauté et d'entretien facile. Profitez-en bien!

Pour installer votre store, veuillez suivre les instructions détaillées. Si vous avez des questions, n'hésitez pas à prendre contact avec notre Centre de service après-vente en téléphonant au 1-800-221-6352 ou par courrier électronique au: windowfashion@springs.com. Nous vous aiderons avec plaisir.

Encore une fois, nous vous remercions de nous avoir choisi pour améliorer et embellir votre intérieur.

1

### Everything needed to install your blind

Todo lo necesario para instalar la persiana  
Tout ce qu'il faut pour la pose du store

Optional • Opcional • Facultatif

Tools Needed  
Herramientas necesarias  
Outillage nécessaire

1/16"  
or  
3/32"

2

### Mark location of blind

Marque el lugar de la persiana  
Marquez l'emplacement du store

**3**

**Determine bracket location - see template**

Determine el lugar de la ménsula  
Déterminez la position du support

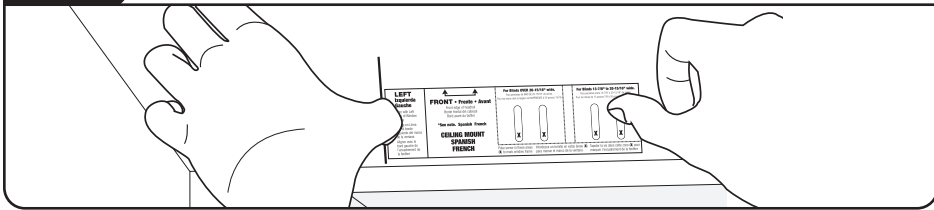

**4**

**Mark bracket location**

Marque el lugar de la ménsula  
Marquez la position du support

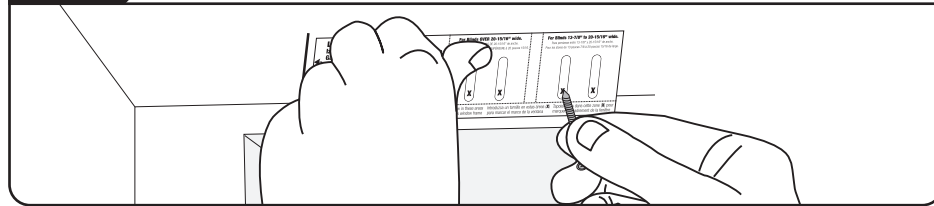

**5**

**Drill holes**

Perfore agujeros  
Percez des trous



**6**

**Screw in brackets**

Atornille las ménsulas  
Vissez les supports

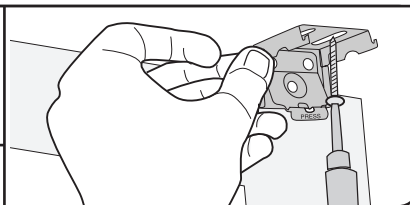

**7**

**Mount blind on brackets**

Instale la persiana en las ménsulas  
Posez le store sur les supports

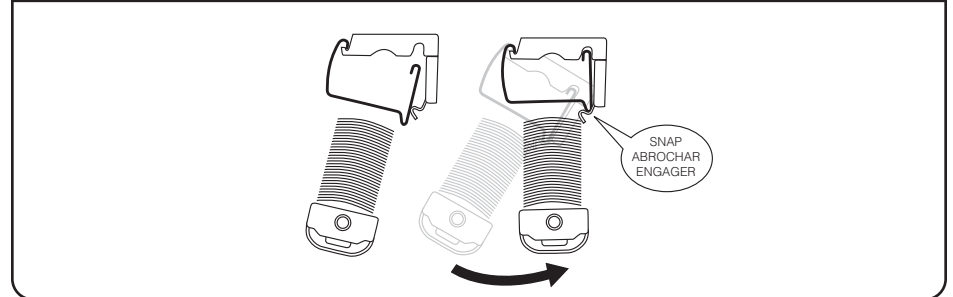
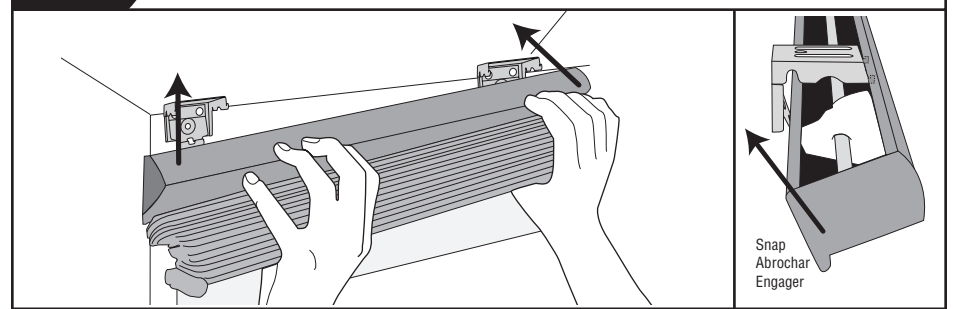

**Optional hold-down brackets**

Opcional soportes sostenedores • Facultatif supports de retenue

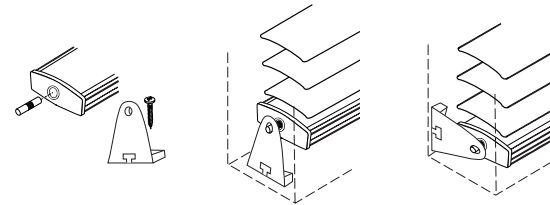

**Use warm water and mild non-abrasive liquid soap**

Use agua caliente y jabón líquido suave no raspante  
Utilisez de l'eau tiède et un savon doux liquide non abrasif

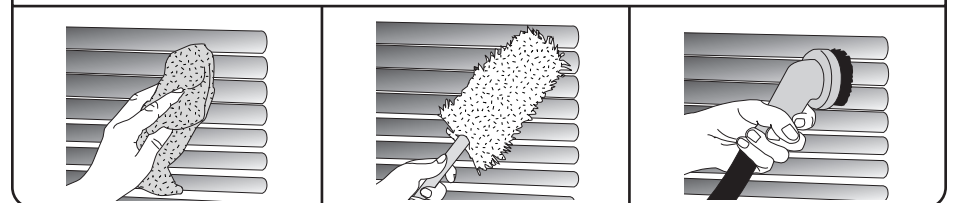

**\*Note:** For blinds under 13-7/8" wide, or all same side control blinds, brackets must be positioned directly over the blind internal tilting components

Nota: Para persianas con un ancho inferior de 13-7/8" y todas las persianas de control del mismo lado, los soportes deben ser colocados directamente sobre los componentes internos de inclinación de la persiana.

Nota: Pour les stores de moins de 13 pouces 7/8 de large, et tous les stores contrôlés du même côté, les supports doivent être positionnés directement au-dessus des pièces d'orientation internes du store.

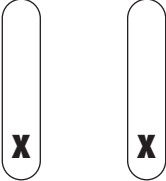
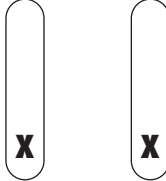
<p><b>LEFT</b> <b>izquierda</b> <b>Gauche</b></p> <p>Align with Left Edge of Window Frame</p> <p>Ponga en Línea con el borde izquierdo del marco de la ventana</p> <p>Aligner avec le bord gauche de l'encadrement de la fenêtre</p>	<p style="text-align: center;">↑                      ↑</p> <p style="text-align: center;"><b>FRONT • Frente • Avant</b></p> <p style="text-align: center;">Front edge of headrail Borde frontal del cabezal Bord avant du boîtier</p> <p style="text-align: center;"><b>*See note. • Ver nota • Voir note.</b></p> <p style="text-align: center;"><b>CEILING MOUNT</b> <b>MONTAJE DE CIELO</b> <b>POSE AU PLAFOND</b></p>	<p><b>For Blinds OVER 20-15/16" wide.</b> Para persianas de MAS DE 20-15/16" de ancho. Pour les stores dont la largeur est SUPÉRIEURE à 20 pouces 15/16.</p> <div style="text-align: center;">  </div> <p>Poke screw in these areas (X) to mark window frame</p>	<p><b>For Blinds 13-7/8" to 20-15/16" wide.</b> Para persianas entre 13-7/8" y 20-15/16" de ancho. Pour les stores de 13 pouces 7/8 à 20 pouces 15/16 de large.</p> <div style="text-align: center;">  </div> <p>Tapoter la vis dans cette zone (X) pour marquer l'encadrement de la fenêtre</p>
--	--	---	---

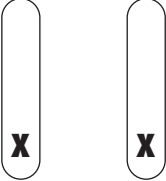
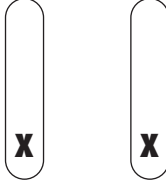
<p><b>For Blinds 13-7/8" to 20-15/16" wide.</b> Para persianas entre 13-7/8" y 20-15/16" de ancho. Pour les stores de 13 pouces 7/8 à 20 pouces 15/16 de large.</p> <div style="text-align: center;">  </div> <p>Poke screw in these areas (X) to mark window frame</p>	<p><b>For Blinds OVER 20-15/16" wide.</b> Para persianas de MAS DE 20-15/16" de ancho. Pour les stores dont la largeur est SUPÉRIEURE à 20 pouces 15/16.</p> <div style="text-align: center;">  </div> <p>Introduzca un tornillo en estas áreas (X) para marcar el marco de la ventana</p> <p>Tapoter la vis dans cette zone (X) pour marquer l'encadrement de la fenêtre</p>	<p style="text-align: center;">↑                      ↑</p> <p style="text-align: center;"><b>FRONT • Frente • Avant</b></p> <p style="text-align: center;">Front edge of headrail Borde frontal del cabezal Bord avant du boîtier</p> <p style="text-align: center;"><b>*See note. • Ver nota • Voir note.</b></p> <p style="text-align: center;"><b>CEILING MOUNT</b> <b>MONTAJE DE CIELO</b> <b>POSE AU PLAFOND</b></p>	<p><b>RIGHT</b> <b>Derecha</b> <b>Droit</b></p> <p>Align with Right Edge of Window Frame</p> <p>Ponga en Línea con el borde derecho del marco de la ventana</p> <p>Aligner avec le bord droit de l'encadrement de la fenêtre</p>
--	---	--	--