

## HEADRAIL INSTALLATION

Insert the headrail into the mounting brackets. If a center support bracket is used, be sure that it properly supports the headrail.

Close the swivel covers to lock the headrail in place.

INSERT HEADRAIL AND CLOSE COVERS



## VALANCE INSTALLATION

If your blind was ordered as an outside mount, the valance is supplied with returns. These are easily attachable with "L" corner adapters. No returns are included with an inside mount.



Attach valance clips to the back of the valance. Position the valance on the headrail and snap into place.

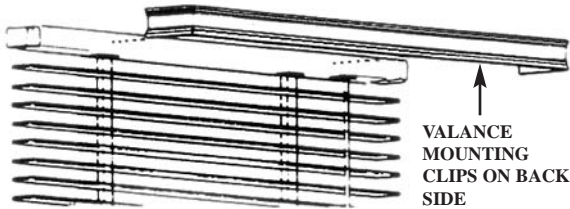

## ADJUSTING BLIND HEIGHT

To raise or lower your blind, pull the cords downward and toward the center of the blind. Raise or lower the blind to the desired height.

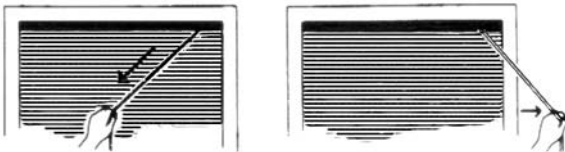

Now pull the cords back past the end of the blind and release them, they will lock automatically.

## OPTIONAL HOLD DOWN BRACKETS

If the blind is to be mounted on a door or somewhere the blind may be blown about by the wind, it is recommended that the hold down brackets be used. The hold down brackets you received with your accessories may be used to secure the bottom-rail of your blind to a door or window sill to prevent the blind from banging into the door or window still when opening or closing, thereby damaging the blind. Please note that when utilizing the hold down brackets the blind may not be raised and lowered.

Fully extend the blind. Insert the brackets in hole as shown in A and B. Mark the hole location where the screws are to be inserted. Try to keep the holes at least 1/4" from the edge of the wood to avoid splitting. You may use 1/16" drill bit or if no drill is available, use a finishing nail and hammer to make small holes to start the screws.

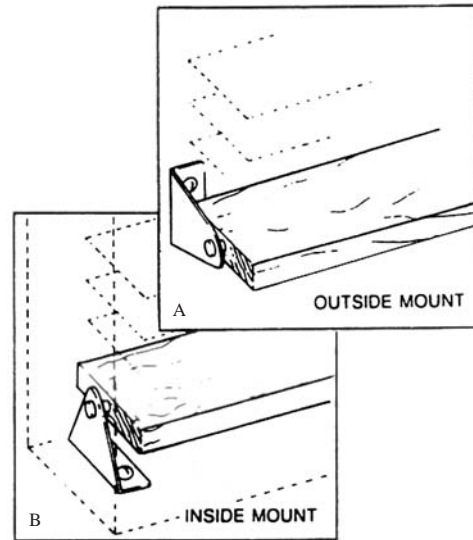

## CLEANING

Your blind is easily cleaned by extending it to its full length and closing the louvers (not tightly) first in one direction and then the other. Wipe them with a soft damp cloth and mild detergent or clean them with your vacuum cleaner's brush attachment. Do not wet cords or ladders.

## Lifetime Limited Warranty

# Wood & Faux Wood Blinds

At Blindsgalore.com we sell only first quality, top of the line products and operate with the highest standards in the industry today. We back everything we sell with a Lifetime Limited Warranty. Blindsgalore.com warrants every product we sell to be free from defects in materials and workmanship for as long as the original retail purchaser owns the product. We provide a 5-year Lifetime Limited Warranty on all mechanical and moving parts on our blinds for normal usage.

Damages resulting from accidents, alterations, misuses, abuse, and exposure to the elements, excessive humidity, fading or discoloration over time, or failure to follow our instructions with respect to measurement, installation, cleaning or maintenance are not covered by this warranty. This warranty also does not cover any condition or damage resulting from removal of the product or reinstallation in the same or another window application. This warranty does not apply to conditions caused by normal wear and tear upon the product.

The obligation of Blindsgalore.com is limited to repair or replacement of the window fashion product or components found to be defective and excludes shipping charges and costs of removal and reinstallation. Repairs will be made with like or similar parts.

For warranty service please contact our Customer Service Department toll free at 1-877-702-5463, or write directly to Customer Service Department, 6555 Nancy Ridge Dr., Suite 100, San Diego, CA 92121. Please include your name and address together with a copy of your original receipt and a description of the specific problem. We can not provide warranty service without a copy of the original receipt.

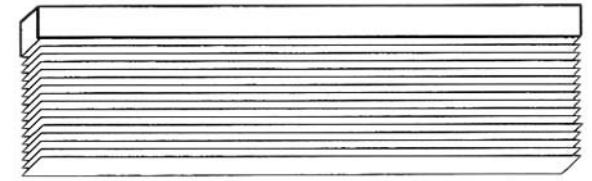

# Blindsgalore America Series, Deluxe Series, Designer Series Faux Wood Blinds and America Series Wood Blinds

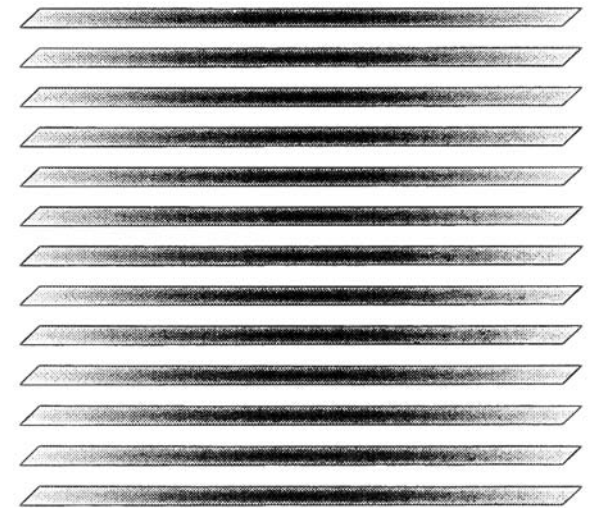

# How to Install Wood & Faux Wood Blinds

Congratulations on your purchase of a quality blind. Your blind has been custom made to your specifications and is one of the finest window treatments available. Before you unwrap your blinds, please take a few moments to read these instructions. With careful installation and periodic cleaning, your blind will provide you with many years of trouble free service.

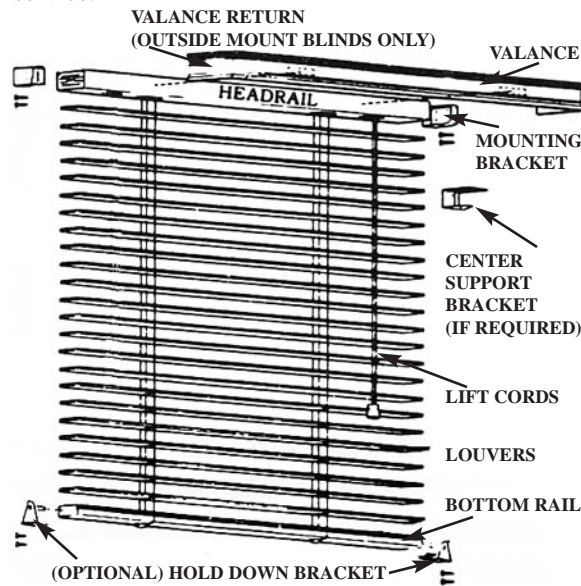

## WARNING!

To avoid possible strangulation, keep cords out of reach of children. Use these devices.

1. Clamp or clothes pin
2. Cleat
3. Tie the cord to itself
4. Tie-down device

### Your blind includes the following:

- Two installation brackets
- Mounting screws
- Valance
- Center support brackets if your blind requires them (48 1/2" or wider)
- Optional hold-down brackets are included

### To install your blind you will need the following tools:

- Pencil
- Screwdriver with phillips head or 1/4" hex driver
- Drill
- 7/64" drill bit or hammer and finishing nail
- Scissors
- Level (optional)
- 1/16" drill bit

## INSTALLATION INSTRUCTIONS

**Unwrap the blind.** Do not untie the cords at this time. Hold the blind against the window to determine proper placement. It will either fit inside the window casing (inside mount) or outside the window casing on the wall (outside mount). This will determine where and how your installation brackets should be attached. Note that the brackets are marked R.H. (Right Hand) and L.H. (Left Hand).

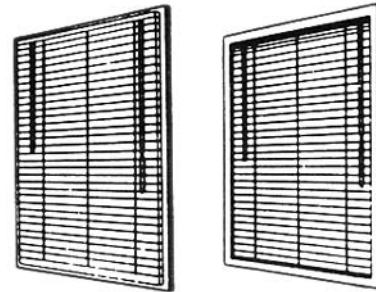

OUTSIDE MOUNT      INSIDE MOUNT

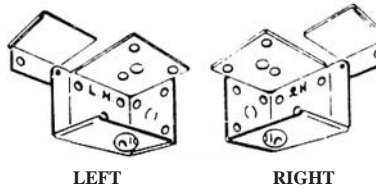

LEFT      RIGHT

**For an Outside Mount,** hold the blind level and center against the window casing. Mark the casing with a pencil just below the headrail on each end. Also mark the window casing 1/8" beyond the ends of the headrail. The right and left installation brackets will be placed on these marks.

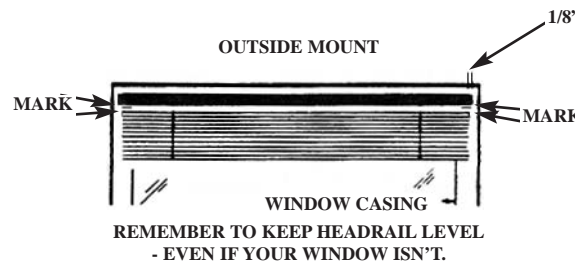

**For an Inside Mount,** make certain the headrail is level and clear of obstructions. Make pencil marks below the headrail on each end. The right hand and left hand installation brackets will be placed on these marks.

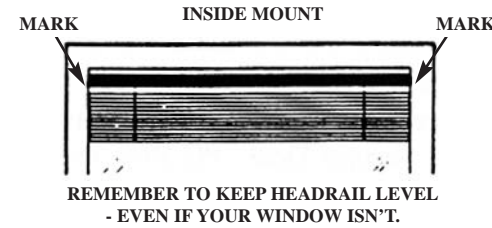

**For a ceiling or a Overhead Mount,** hold the blind against the ceiling centered in front of the window and make pencil marks 1/8" beyond the ends of the headrail. The right and left installation brackets will be placed on these marks.



## MOUNTING INSTALLATION BRACKETS

The brackets may be mounted using two screws in several different orientations depending upon your needs:

- a. Inside the jambs (inside mount).
- b. To the outside face of the window casing or wall (outside mount).
- c. Overhead: either to top inside of the window frame (inside mount) or to the ceiling (outside mount).

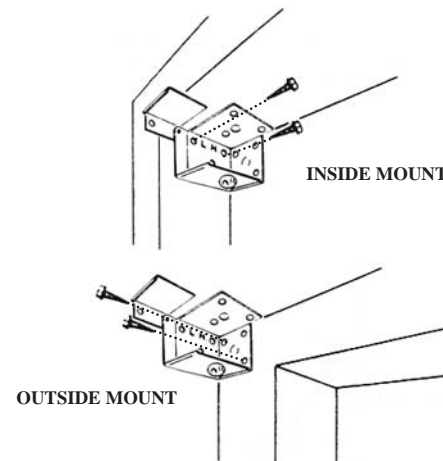

## CEILING OR OVERHEAD MOUNT

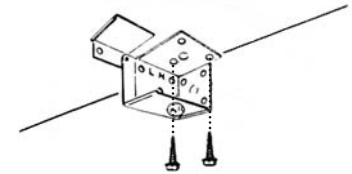

**Hint:** Applying a little bar soap on the screw threads will make them drive more easily.

**Open the brackets swivel cover with a screwdriver.** Hold the brackets against the mounting surface and align it with the pencil marks. Using a pencil, mark the location of the two diagonal holes for the mounting screws. You may drill holes for the screws using 7/64" drill bit, or if a drill is not available, use a finishing nail and hammer or an awl to make small holes to start the screws. Keep the screws at least 1/4" from the edge of the wood to prevent it from splitting.

OPEN COVER WITH SCREWDRIVER

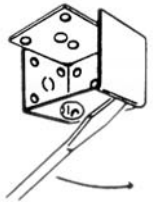

If the mounting surface is metal, you must pre-drill holes for the screws. Use a 1/8" steel drill bit.

If the surface is brick, tile, stone, or concrete, it will be necessary to use a carbide drill and suitable anchors, plugs, or screws. Plaster and wallboard need pre-drilled holes for anchors or plugs. Follow manufacturer's recommendations for these types of fasteners.

## CENTER SUPPORT BRACKETS

If a center support bracket is included with your blind it should be placed in line with the installation brackets.

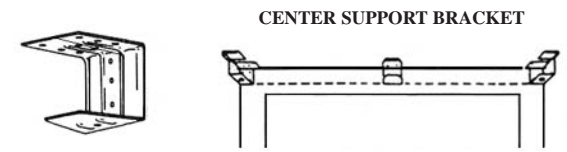

The center support should not be in line vertically with the blind's cord or ladder as it may interfere with the blind's lifting and tilting mechanism.