



Bali[®]
your home, your style

cleaner
look

fuller
view

easy to
install

Measuring
and
Ordering
Guide

euroVUE™
shutters

The better view **YOU** can do.





3/2" Louver EuroVue Shutters in Silk White 1603 with Naples, Bi-fold with Divider Rail

Cleaner Look & Fuller View

The EuroVue Shutter offers a cleaner look with no visible hardware and mitered corners to make your new EuroVue Shutter look like a clean, contemporary part of your window. The EuroVue's design is also free of obstructing frames, so just opening the louvers gives you a fuller view to the outside that other shutters can't match.



2 1/2" Louver in Silk White 1603 with Naples and Standard Tilt



3 1/2" Louver in Cream White 1026 with Geneva and Hidden Tilt



3 1/2" Louver in Snow White 1922 with Monaco, Divider Rail and Hidden Tilt



2 1/2" Louver in Silk White 1603 with Monaco, Divider Rail and Hidden Tilt

Easy to Install

Specifically designed for the Do-it-Yourself, EuroVue is the only shutter on the market that installs as easily as a blind. Simply attach two to three hinges (depending on shutter size and style) and you're done — your beautiful EuroVue Shutter is installed and fully functional.

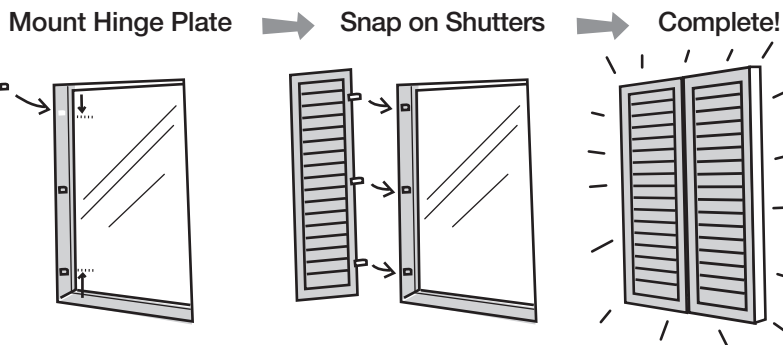

Go to www.baliblinds.com/shutters to view installation videos.



Determine Window Type

The EuroVue Shutter is designed to be a simple DIY project. Complete the following worksheet to order the right shutter for your home. Please note there are some situations where the EuroVue will not work. In those situations, you should select another product from our full line of Bali custom window treatments.

DRYWALL-WRAPPED WINDOWS

Shutters will completely cover window.

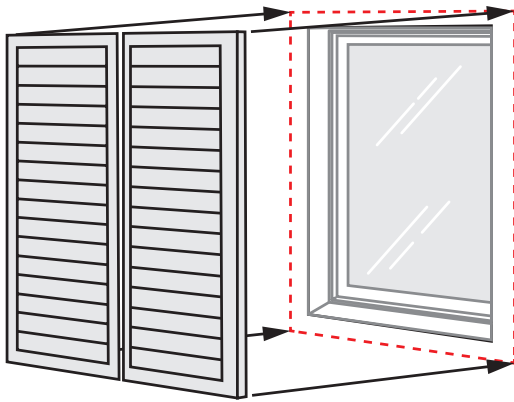

Drywall-wrapped Window

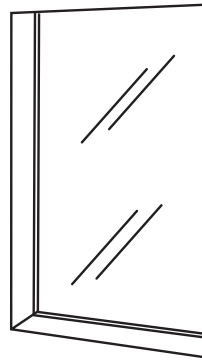

OR

Drywall-wrapped Window with Sill

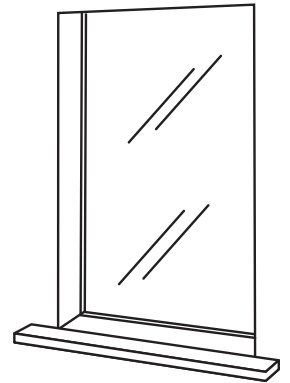

If this is your window type, See page 5.

WOOD-WRAPPED WINDOWS

Shutters will fit inside your window opening.

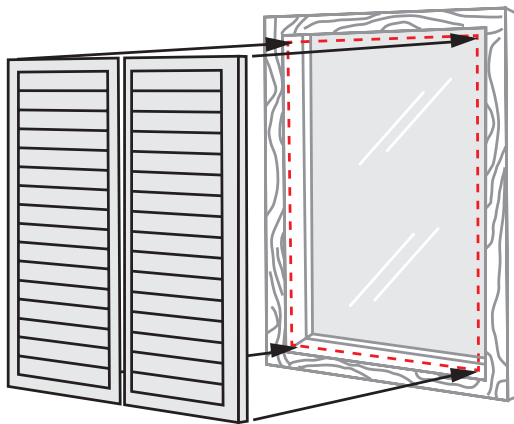

Wood-wrapped Window

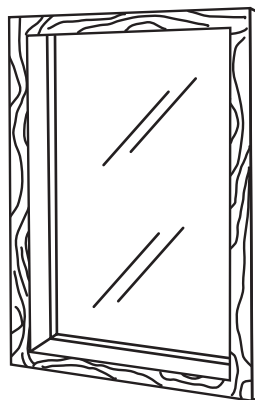

OR

Wood-wrapped Window with Sill

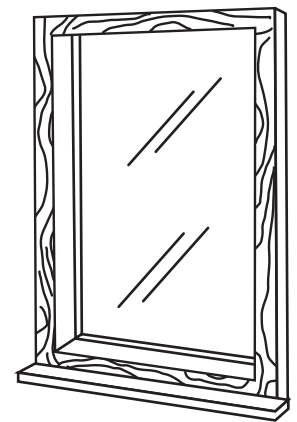

If this is your window type, See page 6.

Drywall-wrapped Window

REQUIREMENT: CHECK FOR CLEARANCE

Check for sufficient clearance for shutter mounting by measuring wall around window edge.

Drywall-wrapped Window **WITHOUT SILL** There must be at least 2 1/8" of clearance on all four sides.

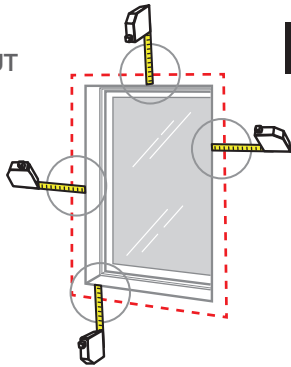

OR

Drywall-wrapped Window **WITH SILL** There must be at least 2 1/8" of clearance on all three sides.

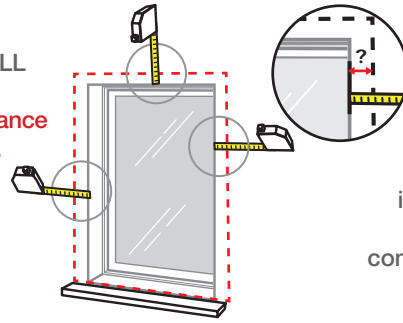

If your measurement is **LESS THAN 2 1/8"**, please consider another Bali® window treatment.

1 MEASURE DEPTH OF WINDOW OPENING TOWARD THE GLASS TO THE FIRST OBSTRUCTION

The first obstruction could be a...

Window Frame

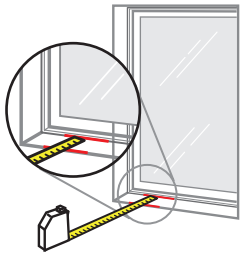

OR

Handle on Double Hung Window

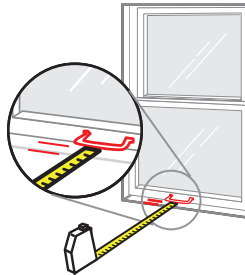

OR

Crank Handle on Casement Window

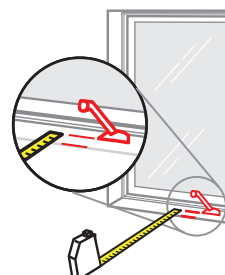

Enter the **SMALLEST** measurement of any of these conditions.

2 MEASURE WINDOW WIDTH

Measure in positions A,B,C and enter the largest of the three widths.

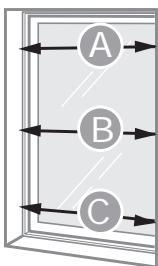

Enter the **LARGEST** measurement of the three widths.

3 MEASURE WINDOW HEIGHT

Measure in positions D,E,F and enter the largest of the three heights. If there's a sill, measure from top of sill.



Enter the **LARGEST** measurement of the three heights.

Go to page 8 to select options.



Wood-wrapped Window

REQUIREMENT: CHECK FOR SQUARENESS

Measure to see if your window is SQUARE.

Measure from opposing corners and record your measurements in the spaces below.

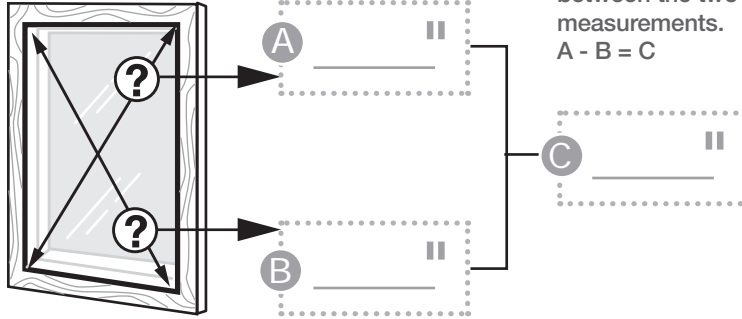

If the DIFFERENCE between the two measurements is MORE THAN 1/4", please consider another Bali window treatment.

REQUIREMENT: CHECK DEPTH OF WINDOW OPENING TOWARD THE GLASS TO THE FIRST OBSTRUCTION

The first obstruction could be a...

Window Frame

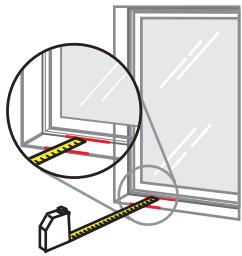

OR

Handle on Double Hung Window

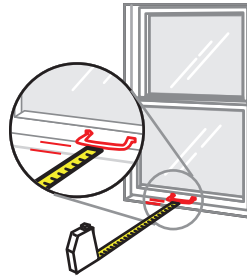

OR

Crank Handle on Casement Window



Enter the SMALLEST measurement of any of these conditions.

IS YOUR WINDOW A TILT-IN OR A NON TILT-IN? (CHOOSE ONE)

Tilt-in Window

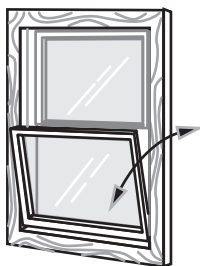

FOR Tilt-in Window

Less than 3 1/2" depth?
If so, please consider another Bali window treatment.



3 1/2" depth or greater?
Please continue to Step 1.

OR

Non Tilt-in Window

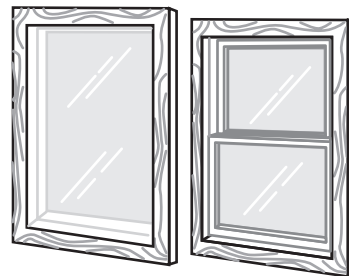

FOR Non Tilt-in Window

Less than 1 1/4" depth?
If so, please consider another Bali window treatment.



1 1/4" depth or greater?
Please continue to Step 1.

Wood-wrapped Window

1 MEASURE WINDOW WIDTH

Measure in positions A,B,C and enter the smallest of the three widths.

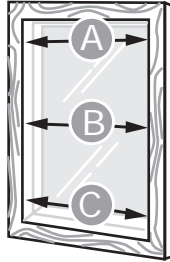

Enter the SMALLEST measurement of the three widths.

-------	--

2 MEASURE WINDOW HEIGHT

Measure in positions D,E,F and enter the smallest of the three heights. If there's a sill, measure from top of sill.

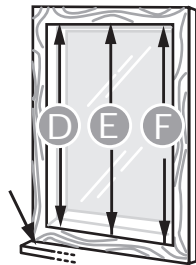

Enter the SMALLEST measurement of the three heights.

-------	--

Go to page 8 to select options.

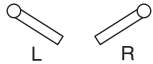
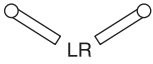
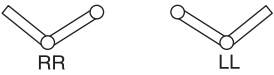
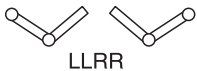

Choose your options

REQUIREMENTS		ORDER WIDTH					
		Geneva and Naples		Monaco		Tuscany	
Panel Configuration	Window Type	Min	Max	Min	Max	Min	Max
Single Panel Only Left or Right 	Drywall	6"	26"	7"	26"	8"	26"
	Wood Wrapped	10 $\frac{1}{4}$ "	30 $\frac{1}{4}$ "	11 $\frac{1}{4}$ "	30 $\frac{1}{4}$ "	12 $\frac{1}{4}$ "	30 $\frac{1}{4}$ "
Double Panels Left and Right 	Drywall	16 $\frac{1}{4}$ "	56 $\frac{1}{8}$ "	18 $\frac{1}{4}$ "	56 $\frac{1}{8}$ "	20 $\frac{1}{4}$ "	56 $\frac{1}{8}$ "
	Wood Wrapped	21 $\frac{1}{2}$ "	60 $\frac{3}{8}$ "	23 $\frac{1}{2}$ "	60 $\frac{3}{8}$ "	25 $\frac{1}{2}$ "	60 $\frac{3}{8}$ "
Double Panel Only Bi-fold Left or Right 	Drywall	16 $\frac{1}{4}$ "	44 $\frac{1}{8}$ "	18 $\frac{1}{4}$ "	44 $\frac{1}{8}$ "	20 $\frac{1}{4}$ "	44 $\frac{1}{8}$ "
	Wood Wrapped	21 $\frac{1}{2}$ "	48 $\frac{3}{8}$ "	23 $\frac{1}{2}$ "	48 $\frac{3}{8}$ "	25 $\frac{1}{2}$ "	48 $\frac{3}{8}$ "
Double Panels Bi-fold Left and Right 	Drywall	36 $\frac{5}{8}$ "	92 $\frac{1}{2}$ "	40 $\frac{5}{8}$ "	92 $\frac{1}{2}$ "	44 $\frac{5}{8}$ "	92 $\frac{1}{2}$ "
	Wood Wrapped	40 $\frac{7}{8}$ "	96 $\frac{3}{4}$ "	44 $\frac{7}{8}$ "	96 $\frac{3}{4}$ "	48 $\frac{7}{8}$ "	96 $\frac{3}{4}$ "

SELECT PANEL EDGE DESIGN

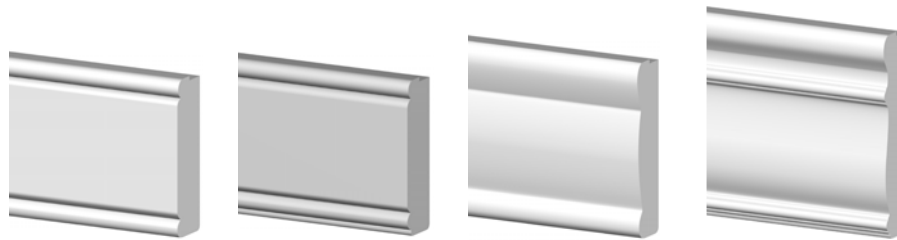

	Geneva	Naples	Monaco	Tuscany
Max Panel Height	84"	84"	84"	96"
Max Panel Height WITHOUT Divider Rail	60"	60"	72"	72"

Enter panel edge design below.

LIMITATIONS FOR ORDER HEIGHTS

Window Trim	Geneva and Naples				Monaco				Tuscany			
	no sill		with sill		no sill		with sill		no sill		with sill	
	min	max	min	max	min	max	min	max	min	max	min	max
Drywall	11"	80"	13 $\frac{1}{8}$ "	82 $\frac{1}{8}$ "	14"	80"	16 $\frac{1}{8}$ "	82 $\frac{1}{8}$ "	17"	92"	19 $\frac{1}{8}$ "	95 $\frac{1}{8}$ "
Wood Wrapped	15 $\frac{1}{4}$ "	84 $\frac{1}{4}$ "	15 $\frac{1}{4}$ "	84 $\frac{1}{4}$ "	18 $\frac{1}{4}$ "	84 $\frac{1}{4}$ "	18 $\frac{1}{4}$ "	84 $\frac{1}{4}$ "	21 $\frac{1}{4}$ "	96 $\frac{1}{4}$ "	21 $\frac{1}{4}$ "	96 $\frac{1}{4}$ "

Choose more options

SELECT LOUVER SIZE

Two different louver sizes are available to let you choose the look that's right for you.

2½" Louver

A perfect size without overwhelming other design elements in your room.



3½" Louver

Provides design versatility that can accommodate any décor and offers great view to the outside when open.



Enter louver size below.

SELECT SHUTTER COLOR

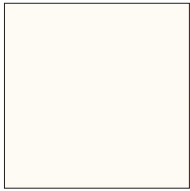

Snow White
1922

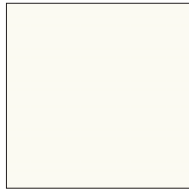

Silk White
1603

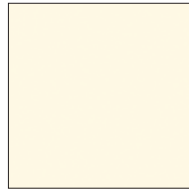

Dove White
1683

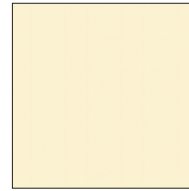

Cream White
1026

Enter color number below.

DECIDE WHETHER YOU WANT OR NEED A DIVIDER RAIL

Divider rails are used to add strength to tall shutters. Shutters taller than the maximum height listed under the panel edge designs on page 8 will automatically include a centered divider rail.

Divider rails can also be added to shorter shutters as a decorative element or to create a top open/bottom closed effect that maintains privacy while letting in light. In this case, the divider rail can be centered or placed anywhere up to four louvers from the top or bottom of the shutter. To order a divider rail that is not centered, measure from the bottom of your window opening to the point where you want the center of the divider rail located.

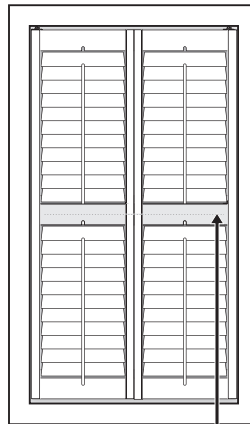

Enter "yes" or "no."

Divider Rail Placement
Enter "centered" or "(inches) from bottom."

DETERMINE TILT TYPE

Standard Tilt

Standard tilt features a tilt bar on the front of the panel.

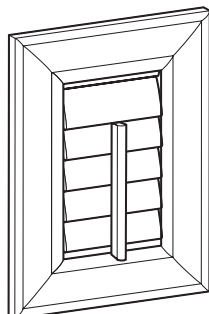

Hidden Tilt

Stainless steel tilt bar on back of panel (on hinge side) requires additional 1/8" clearance.

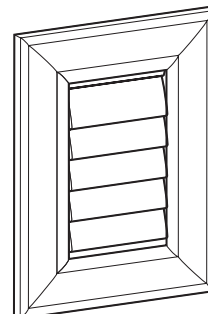

Enter tilt type below.



Order Information Worksheet

Please use the notes from prior pages to complete. Bring this worksheet to the store to place your order.

NOTE: USE THE BELOW SECTION FOR THE MEASUREMENTS OF ONE WINDOW ONLY.

Window Type		Window Tilt	Depth (inches)	Width (inches)	Height (inches)	Color
<input type="checkbox"/> Drywall-wrapped window without sill <input type="checkbox"/> Drywall-wrapped window with sill <input type="checkbox"/> Wood-wrapped window without sill <input type="checkbox"/> Wood-wrapped window with sill		<input type="checkbox"/> Tilt-in Window <input type="checkbox"/> Non Tilt-in Window				<input type="checkbox"/> Snow White <input type="checkbox"/> Silk White <input type="checkbox"/> Dove White <input type="checkbox"/> Cream White
Louver Size	Panel Edge Design	Panel Configuration		Divider Rail	Tilt Type	Room (for shutter placement)
<input type="checkbox"/> 2½" <input type="checkbox"/> 3½"	<input type="checkbox"/> Geneva <input type="checkbox"/> Naples <input type="checkbox"/> Monaco <input type="checkbox"/> Tuscany	<input type="checkbox"/> L <input type="checkbox"/> R	<input type="checkbox"/> LL <input type="checkbox"/> RR	<input type="checkbox"/> LR <input type="checkbox"/> LLRR	<input type="checkbox"/> Yes <input type="checkbox"/> No <input type="checkbox"/> Center <input type="checkbox"/> Height _____	<input type="checkbox"/> Standard Tilt <input type="checkbox"/> Hidden Tilt

NOTE: USE THE BELOW SECTION FOR THE MEASUREMENTS OF ONE WINDOW ONLY.

Window Type		Window Tilt	Depth (inches)	Width (inches)	Height (inches)	Color
<input type="checkbox"/> Drywall-wrapped window without sill <input type="checkbox"/> Drywall-wrapped window with sill <input type="checkbox"/> Wood-wrapped window without sill <input type="checkbox"/> Wood-wrapped window with sill		<input type="checkbox"/> Tilt-in Window <input type="checkbox"/> Non Tilt-in Window				<input type="checkbox"/> Snow White <input type="checkbox"/> Silk White <input type="checkbox"/> Dove White <input type="checkbox"/> Cream White
Louver Size	Panel Edge Design	Panel Configuration		Divider Rail	Tilt Type	Room (for shutter placement)
<input type="checkbox"/> 2½" <input type="checkbox"/> 3½"	<input type="checkbox"/> Geneva <input type="checkbox"/> Naples <input type="checkbox"/> Monaco <input type="checkbox"/> Tuscany	<input type="checkbox"/> L <input type="checkbox"/> R	<input type="checkbox"/> LL <input type="checkbox"/> RR	<input type="checkbox"/> LR <input type="checkbox"/> LLRR	<input type="checkbox"/> Yes <input type="checkbox"/> No <input type="checkbox"/> Center <input type="checkbox"/> Height _____	<input type="checkbox"/> Standard Tilt <input type="checkbox"/> Hidden Tilt

NOTE: USE THE BELOW SECTION FOR THE MEASUREMENTS OF ONE WINDOW ONLY.

Window Type		Window Tilt	Depth (inches)	Width (inches)	Height (inches)	Color
<input type="checkbox"/> Drywall-wrapped window without sill <input type="checkbox"/> Drywall-wrapped window with sill <input type="checkbox"/> Wood-wrapped window without sill <input type="checkbox"/> Wood-wrapped window with sill		<input type="checkbox"/> Tilt-in Window <input type="checkbox"/> Non Tilt-in Window				<input type="checkbox"/> Snow White <input type="checkbox"/> Silk White <input type="checkbox"/> Dove White <input type="checkbox"/> Cream White
Louver Size	Panel Edge Design	Panel Configuration		Divider Rail	Tilt Type	Room (for shutter placement)
<input type="checkbox"/> 2½" <input type="checkbox"/> 3½"	<input type="checkbox"/> Geneva <input type="checkbox"/> Naples <input type="checkbox"/> Monaco <input type="checkbox"/> Tuscany	<input type="checkbox"/> L <input type="checkbox"/> R	<input type="checkbox"/> LL <input type="checkbox"/> RR	<input type="checkbox"/> LR <input type="checkbox"/> LLRR	<input type="checkbox"/> Yes <input type="checkbox"/> No <input type="checkbox"/> Center <input type="checkbox"/> Height _____	<input type="checkbox"/> Standard Tilt <input type="checkbox"/> Hidden Tilt

Additional worksheets are available at www.baliblinds.com/shutters.

Additional Notes

DELIVERY Shutters will be delivered in approximately six weeks.

SHIPPING DAMAGE Report any shipping damage to the consumer hotline telephone number: 1-800-221-6352

CHANGES/MODIFICATIONS Orders cannot be changed or modified after one business day from the original order date.